

V2024\_N2K

# Retro Fit Bidet Catalogue

The Ultimate bathroom renovation simply  
by changing your existing seat.  
Install an Electronic Bidet  
Retro-Fit Seat today!

**The**<sup>®</sup>  
**BIDET**  
**SHOP**

A close-up, high-angle photograph of a Coway bidet seat. The seat is white with a black control panel on the left side. The control panel features a small LCD screen, several circular buttons with icons, and two larger triangular buttons. The brand name 'Coway' is printed in black on the top left of the seat. The background is a dark, curved surface, likely the toilet bowl.

**coway**

 Voted "Best Bidet in the world" 2 years in a row at the World Design Awards

# Will my new Bidet fit my toilet?



First thing to do is to measure from the front of the cistern to the front of the bowl. **(A)**



Measure the distance between the bolt holes **(B)**



Measure inside the bowl, front to back. **(C)**



Measure from the centre of the bolt holes to the front of the bowl. **(D)**

**Write your measurements here:**

**(A):** \_\_\_\_\_ cm

**(B):** \_\_\_\_\_ cm

**(C):** \_\_\_\_\_ cm

**(D):** \_\_\_\_\_ cm



Is there a tap behind the toilet?

Is there access to the bolts under the back of the seat?



*If your toilet is different don't worry we have a Bidet to suit most toilet pans. Call the help line and they will help you find a Bidet suitable for your situation.*

List of Bidet models requiring a minimum of **480mm** flat surface from front of cistern to front of bowl.

Model	Inside bowl measurement
BA13AR/BR	310mm or above

List of Bidet models requiring a minimum of **490mm** flat surface from front of cistern to front of bowl.

Model	Inside bowl measurement
EB-R500R	320mm or above
N800/1000	320mm or above
N2000R	335mm or above
Air 9000R	Between 320-330mm

**POWER POINT WITHIN 1.5 METRES EITHER SIDE**

(\*As long as there is open access at rear of toilet)

*Certain model Bidets can be fitted if the water supply is inside the cistern*

**EXTERNAL TAP REQUIRED CAN BE EITHER SIDE**

(\*As long as there is open access at rear of toilet)

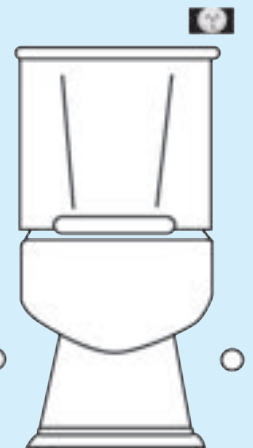

\*If unsure: Please check with your electrician for power point placement

**OPERATING WATER PRESSURE**

100kpa to 680kpa

List of Bidet models requiring a minimum of **500mm** flat surface from front of cistern to front of bowl.

Model	Inside bowl measurement
BA08R	330mm or above
N2000U	345mm or above
BA13AE/BE	340mm or above
Air9000E	350mm or above

List of Bidet models requiring a minimum of **520mm** flat surface from front of cistern to front of bowl.

Model	Inside bowl measurement
EB-R500E	340mm or above
BA08E	340mm or above
Intelicare	340mm or above
Inteliwash	340mm or above
N2000E	355mm or above

**IMPORTANT INFO:** When facing the toilet, the power is on the **right hand side** and the water connection on the **left**

\*If power or water is on opposite sides a longer pipe may be required and a clear access behind the toilet is preferred. We have a Bidet for most of all applications. If your toilet differs to this, please contact the supplier or support centre on 1300 243 387.

## National

New style and innovative design

Available in:

Standard seat 



\*Night Light



### National N800 (Standard Seat)

This Bidet will fit on your existing toilet suite if the measurements of your pan are:

- A:** 490mm or above
- B:** Between 135-195mm
- C:** 320mm or above\*
- D:** 410mm or above

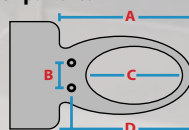

\* At 320mm once installed some porcelain may be visible. 330mm is the preferred size.

## FEATURES

- NOZZLE (x1)
- WATER SAVING
- REAR CLEANSE
- COLD WATER OPTION
- ONE BUTTON WASH FUNCTION
- ANTI-BACTERIAL PLASTIC
- SIDE CONTROL
- FEMININE CLEANSE
- SOFT CLOSE HYDRAULIC LID
- ERGONOMIC SEAT
- FILTER EXTERNAL
- AIR AND WATER STREAM
- ENERGY (power) SAVE
- MF FILTER
- HEATED WATER
- NOZZLE CLEAN FUNCTION
- HEATED SEAT
- ELECTRICAL (power point req.)
- SEAT SENSOR
- SELF CLEANSING NOZZLE
- INSTANTANEOUS HEAT (fast heat)
- QUICK RELEASE
- REMOTE CONTROL
- MINI SIDE CONTROL
- ULTRA STREAMLINE DESIGN
- FILTER IN-BUILT
- HEATED DRYER
- MASSAGE/MOVE
- NOZZLE POSITION ADJUST
- SELF DIAGNOSIS
- WIDE, MEDIUM, NARROW SPRAY
- PULSE
- CHILD
- DEODORISER
- ENEMA
- USER PRESETS
- WET AREA RATED IPX4
- REMOVABLE SIDE REMOTE CONTROL
- STAINLESS STEEL NOZZLE
- SILVER IONISATION
- FIT INTERNAL CISTERN (kit required)
- FIT BACK TO WALL SUITE
- FIT ENCLOSED SUITE

For detailed information and instructions **scan below** or **click here**



This Bidet has passed electrical and watermark certification. Local plumbing regulations may apply.



## National

New style and innovative design

Available in:

Standard seat 



REMOTE CONTROL



\*Night Light



### National N1000 (Standard Seat)

This Bidet will fit on your existing toilet suite if the measurements of your pan are:

- A:** 490mm or above
- B:** Between 135-195mm
- C:** 320mm or above\*
- D:** 410mm or above

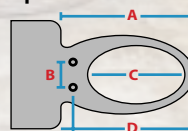

\* At 320mm once installed some porcelain may be visible. 330mm is the preferred size.

## FEATURES

- NOZZLE (x1)
- WATER SAVING
- REAR CLEANSE
- COLD WATER OPTION
- ONE BUTTON WASH FUNCTION
- ANTI-BACTERIAL PLASTIC
- SIDE CONTROL
- FEMININE CLEANSE
- SOFT CLOSE HYDRAULIC LID
- ERGONOMIC SEAT
- FILTER EXTERNAL
- AIR AND WATER STREAM
- ENERGY (power) SAVE
- MF FILTER
- HEATED WATER
- NOZZLE CLEAN FUNCTION
- HEATED SEAT
- ELECTRICAL (power point req.)
- SEAT SENSOR
- SELF-CLEANSING NOZZLE
- INSTANTANEOUS HEAT
- QUICK RELEASE
- REMOTE CONTROL
- MINI SIDE CONTROL
- ULTRA STREAMLINE DESIGN
- FILTER IN-BUILT
- HEATED DRYER
- MASSAGE/MOVE
- NOZZLE POSITION ADJUST
- SELF-DIAGNOSIS
- WIDE, MEDIUM, NARROW SPRAY
- PULSE
- CHILD
- DEODORISER
- ENEMA
- USER PRESETS
- WET AREA RATED IPX4
- REMOVABLE SIDE REMOTE CONTROL
- STAINLESS STEEL NOZZLE
- SILVER IONISATION
- FIT INTERNAL CISTERN (kit required)
- FIT BACK TO WALL SUITE
- FIT ENCLOSED SUITE

For detailed information and instructions **scan below** or **click here**





This Bidet has passed electrical and watermark certification. Local plumbing regulations may apply.

## National

New style and innovative design

**Available in:**

- Standard seat 
- 'U' Shaped seat 
- Elongated seat 



\*Night Light

### Our newest ultra-sleek bidet

Ultra slim design and 180 kg weight capacity

Classy and elegant design for your contemporary bathroom



**National N-2000 (Standard Seat)**

This Bidet will fit on your existing toilet suite if the measurements of your pan are:

- A: 495mm or above
- B: Between 135-195mm
- C: 335mm or above
- D: Bet. 425mm - 475mm

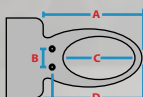

**National N-2000 ('U Shaped' Seat)**

This Bidet will fit on your existing toilet suite if the measurements of your pan are:

- A: 515mm or above
- B: Between 135-195mm
- C: 345mm or above
- D: Bet. 445mm - 490mm

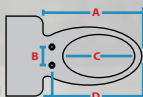

**National N-2000 (Elongated Seat)**

This Bidet will fit on your existing toilet suite if the measurements of your pan are:

- A: 520mm or above
- B: Between 135-195mm
- C: 355mm or above
- D: Bet. 445mm - 495mm

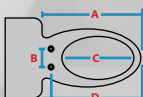

## FEATURES

- NOZZLE (x1)
- WATER SAVING
- REAR CLEANSE
- COLD WATER OPTION
- ONE BUTTON WASH FUNCTION
- ANTI-BACTERIAL PLASTIC
- SIDE CONTROL
- FEMININE CLEANSE
- SOFT CLOSE HYDRAULIC LID
- ERGONOMIC SEAT
- FILTER EXTERNAL
- AIR AND WATER STREAM
- ENERGY (power) SAVE
- MF FILTER
- HEATED WATER
- NOZZLE CLEAN FUNCTION
- HEATED SEAT
- ELECTRICAL (power point req.)
- SEAT SENSOR
- SELF CLEANSING NOZZLES
- INSTANTANEOUS HEAT
- QUICK RELEASE
- REMOTE CONTROL
- MINI SIDE CONTROL
- ULTRA STREAMLINE DESIGN
- FILTER IN-BUILT
- HEATED DRYER
- MASSAGE/MOVE
- NOZZLE POSITION ADJUST
- SELF DIAGNOSIS
- WIDE, MEDIUM, NARROW SPRAY
- PULSE
- CHILD
- DEODORISER
- ENEMA
- USER PRESETS
- WET AREA RATED IPX4
- REMOVABLE SIDE REMOTE CONTROL
- STAINLESS STEEL NOZZLE
- SILVER IONISATION
- FIT INTERNAL CISTERN (kit required)
- FIT BACK TO WALL SUITE
- FIT ENCLOSED SUITE

For detailed information and instructions **scan below** or **click here**



*This Bidet has passed electrical and watermark certification. Local plumbing regulations may apply.*



# Eco Bidet-R500



Electric Bidet EB-R500

**Available in:**

- Standard seat
- Elongated seat



\*Night Light



A CLEANER FUTURE ECO-NOMICAL + ECO-LOGICAL

## FEATURES

- NOZZLE (x1)
- WATER SAVING
- REAR CLEANSE
- COLD WATER OPTION
- ONE BUTTON WASH FUNCTION
- ANTI-BACTERIAL PLASTIC
- SIDE CONTROL
- FEMININE CLEANSE
- SOFT CLOSE HYDRAULIC LID
- ERGONOMIC SEAT
- FILTER EXTERNAL
- AIR AND WATER STREAM
- ENERGY (power) SAVE
- MF FILTER (optional)
- HEATED WATER
- NOZZLE CLEAN FUNCTION
- HEATED SEAT
- ELECTRICAL (power point req.)
- SEAT SENSOR
- SELF CLEANSING NOZZLE
- INSTANTANEOUS HEAT
- QUICK RELEASE
- REMOTE CONTROL
- MINI SIDE CONTROL
- ULTRA STREAMLINE DESIGN
- FILTER IN-BUILT
- HEATED DRYER
- MASSAGE/MOVE
- NOZZLE POSITION ADJUST
- SELF DIAGNOSIS
- WIDE, MEDIUM, NARROW SPRAY
- PULSE
- CHILD
- DEODORISER
- ENEMA
- USER PRESETS
- WET AREA RATED IPX4
- REMOVABLE SIDE REMOTE CONTROL
- STAINLESS STEEL SHAFT
- SILVER IONISATION
- FIT INTERNAL CISTERN (kit required)
- FIT BACK TO WALL SUITE
- FIT ENCLOSED SUITE

**The EB-R500 is fully featured:**  
Hi-tech Wireless Remote control that can be programmed for 2 different users



For detailed information and instructions **scan below** or **click here**



**Eco Bidet S500 (Standard Seat)**

This Bidet will fit on your existing toilet suite if the measurements of your pan are:

- A:** 490mm or above
- B:** Between 135-195mm
- C:** 320mm or above\*
- D:** 410mm or above

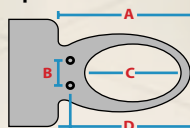

**Eco Bidet S500 (Elongated Seat)**

This Bidet will fit on your existing toilet suite if the measurements of your pan are:

- A:** 520mm or above
- B:** Between 135-195mm
- C:** 340mm or above
- D:** 440mm or above

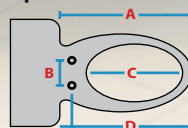

\* At 320mm once installed some porcelain may be visible. 330mm is the preferred size.





This Bidet has passed electrical and watermark certification. Local plumbing regulations may apply.

# Inteliclean Air 9000

## InteliClean

**+** Health Care and Medical Bidet

### Available in:

- Standard seat 
- Elongated seat 



\*Night Light



## Australia's most advanced bidet system

This fully certified bidet does not require any additional backflow device



## FEATURES

- NOZZLE (x1)
- WATER SAVING
- REAR CLEANSE
- COLD WATER OPTION
- ONE BUTTON WASH FUNCTION
- ANTI-BACTERIAL PLASTIC
- SIDE CONTROL
- FEMININE CLEANSE
- SOFT CLOSE HYDRAULIC LID
- ERGONOMIC SEAT
- FILTER EXTERNAL
- AIR AND WATER STREAM
- ENERGY (power) SAVE
- MF FILTER (optional)
- HEATED WATER
- NOZZLE CLEAN FUNCTION
- HEATED SEAT
- ELECTRICAL (power point req.)
- SEAT SENSOR
- SELF CLEANSING NOZZLE
- INSTANTANEOUS HEAT
- QUICK RELEASE
- REMOTE CONTROL
- MINI SIDE CONTROL
- ULTRA STREAMLINE DESIGN
- FILTER IN-BUILT
- HEATED DRYER
- MASSAGE/MOVE
- NOZZLE POSITION ADJUST
- SELF DIAGNOSIS
- WIDE, MEDIUM, NARROW SPRAY
- PULSE
- CHILD
- DEODORISER
- ENEMA
- USER PRESETS
- WET AREA RATED IPX4
- REMOVABLE SIDE REMOTE CONTROL
- STAINLESS STEEL SHAFT
- SILVER IONISATION
- FIT INTERNAL CISTERN (kit required)
- FIT BACK TO WALL SUITE
- FIT ENCLOSED SUITE

For detailed information and instructions **scan below** or **click here**



### Inteliclean Air 9000 (Standard Seat)

This Bidet will fit on your existing toilet suite if the measurements of your pan are:

- A: 490mm or above
- B: Between 135-195mm
- C: 320-330mm\*
- D: 420mm or above

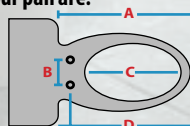

### Inteliclean Air 9000 (Elongated Seat)

This Bidet will fit on your existing toilet suite if the measurements of your pan are:

- A: 510mm or above
- B: Between 135-195mm
- C: 350mm or above
- D: 440mm or above

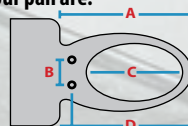

\*Porcelain may show on fittings under 330mm. C measurement is 310mm (R) or 330mm (E) without shroud.



This Bidet has passed electrical and watermark certification. Local plumbing regulations may apply.

## InteliCare

The latest generation in Hygiene Technology

Available in:

Elongated seat 



\*Night Light



### A bidet made for ease of use

The InteliCare bidet has all the standard features, such as: rear wash, ladies wash, and air dryer;

Plus multi-position, 5-step nozzle adjustment, as well as pulse and oscillate settings to provide a much cleaner wash.



#### InteliCare

This Bidet will fit on your existing toilet suite if the measurements of your pan are:

- A:** 520mm or above
- B:** Between 140-195mm
- C:** 340mm or above
- D:** Bet. 425mm - 489mm

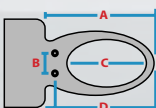

## FEATURES

- NOZZLE (x1)
- WATER SAVING
- REAR CLEANSE
- COLD WATER OPTION
- ONE BUTTON WASH FUNCTION
- ANTI-BACTERIAL PLASTIC
- SIDE CONTROL
- FEMININE CLEANSE
- SOFT CLOSE HYDRAULIC LID
- ERGONOMIC SEAT
- FILTER EXTERNAL
- AIR AND WATER STREAM
- ENERGY (power) SAVE
- MF FILTER
- HEATED WATER
- NOZZLE CLEAN FUNCTION
- HEATED SEAT
- ELECTRICAL (power point req.)
- SEAT SENSOR
- SELF CLEANSING NOZZLES
- INSTANTANEOUS HEAT
- QUICK RELEASE
- REMOTE CONTROL
- MINI SIDE CONTROL
- ULTRA STREAMLINE DESIGN
- FILTER IN-BUILT
- HEATED DRYER
- MASSAGE/MOVE
- NOZZLE POSITION ADJUST
- SELF DIAGNOSIS
- WIDE, MEDIUM, NARROW SPRAY
- PULSE
- CHILD
- DEODORISER
- ENEMA
- USER PRESETS
- WET AREA RATED IPX4
- REMOVABLE SIDE REMOTE CONTROL
- STAINLESS STEEL NOZZLE
- SILVER IONISATION
- FIT INTERNAL CISTERN (kit required)
- FIT BACK TO WALL SUITE
- FIT ENCLOSED SUITE

For detailed information and instructions **scan below** or **click here**



This Bidet has passed electrical and watermark certification. Local plumbing regulations may apply.



## InteliWash

The latest generation in Hygiene Technology

Available in:

Elongated seat 



\*Night Light

### Sleek and simple to operate

The InteliWash bidet provides ultimate performance with the least amount of buttons-- its advanced technology has allowed so many features and functions to be compressed into a simple slimline design.

#### InteliWash

This Bidet will fit on your existing toilet suite if the measurements of your pan are:

- A:** 520mm or above
- B:** Between 140-195mm
- C:** 340mm or above
- D:** Bet. 430mm - 489mm

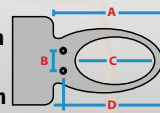

### FEATURES

- NOZZLE (x1)
- WATER SAVING
- REAR CLEANSE
- COLD WATER OPTION
- ONE BUTTON WASH FUNCTION
- ANTI-BACTERIAL PLASTIC
- SIDE CONTROL
- FEMININE CLEANSE
- SOFT CLOSE HYDRAULIC LID
- ERGONOMIC SEAT
- FILTER EXTERNAL
- AIR AND WATER STREAM
- ENERGY (power) SAVE
- MF FILTER
- HEATED WATER
- NOZZLE CLEAN FUNCTION
- HEATED SEAT
- ELECTRICAL (power point req.)
- SEAT SENSOR
- SELF CLEANSING NOZZLES
- INSTANTANEOUS HEAT
- QUICK RELEASE
- REMOTE CONTROL
- MINI SIDE CONTROL
- ULTRA STREAMLINE DESIGN
- FILTER IN-BUILT
- HEATED DRYER
- MASSAGE/MOVE
- NOZZLE POSITION ADJUST
- SELF DIAGNOSIS
- WIDE, MEDIUM, NARROW SPRAY
- PULSE
- CHILD
- DEODORISER
- ENEMA
- USER PRESETS
- WET AREA RATED IPX4
- REMOVABLE SIDE REMOTE CONTROL
- STAINLESS STEEL NOZZLE
- SILVER IONISATION
- FIT INTERNAL CISTERN (kit required)
- FIT BACK TO WALL SUITE
- FIT ENCLOSED SUITE

For detailed information and instructions **scan below** or **click here**



This Bidet has passed electrical and watermark certification. Local plumbing regulations may apply.



# FEATURES



# FEATURES EXPLAINED...

<b>NOZZLE</b>	Separate nozzles designed for the rear cleansing and the ladies wash prevents cross contamination keeping you healthier and cleaner.
<b>WATER SAVING</b>	An average wash uses about a tea cup or two of water.
<b>REAR CLEANS</b>	This function is for washing the bottom area only.
<b>COLD WATER OPTION</b>	Water temperature can be turned off. Offering a cool soothing spray for those hot sticky days.
<b>ONE BUTTON WASH FUNCTION</b>	Designed to make the operation of the Bidet's features easy to access.
<b>ANTI-BACTERIAL PLASTIC</b>	The Bidet is made with anti-bacterial plastic to ensure a highest degree of hygiene & cleanliness.
<b>SIDE CONTROL</b>	All controls are placed on an arm on the right side (when you are seated) of the Bidet.
<b>FEMININE CLEANS</b>	Use this button to use the front cleansing front function exclusively for women.
<b>SOFT CLOSE HYDRAULIC LID</b>	Hydraulic dampers installed at the hinges allow the seat and lid to close softly.
<b>ERGONOMIC SEAT</b>	The ergonomically designed seat is stable, secure and allows comfort for extended use.
<b>FILTER EXTERNAL</b>	Either the MF filter or standard sediment filter is mounted externally.
<b>AIR AND WATER STREAM</b>	Air bubbles are injected into the water stream to create a softer, gentler feel while giving a 40% better wash.
<b>ENERGY (power) SAVE</b>	The Bidet senses when it is not occupied and will automatically go into "power save mode". This function can be turned off and on.
<b>MF FILTER</b>	This filter removes sediment from the water protecting the Bidet and provides a natural disinfectant that helps kill bacteria.
<b>HEATED WATER</b>	The water stream temperature is adjustable. The temperature can be set to 3 levels. You set exactly the temperature you prefer for as long as you want.
<b>NOZZLE CLEAN FUNCTION / BUTTON</b>	Press this buttons to manually clean the nozzles rarely used as the Bidet cleans nozzles automatically every time you use it.
<b>HEATED SEAT</b>	Heated seat offers 3 temperature settings - great for those cold/winter mornings.
<b>ELECTRICAL (power point req.)</b>	Bidet requires a standard 240volt 10amp electrical outlet.
<b>SEAT SENSOR</b>	Bidet cannot operate unless the seat is occupied. This function can be turned off on Coway models.
<b>SELF CLEANSING NOZZLE/S</b>	Each time you use the rear/front cleansing function, the Bidet automatically cleans the nozzle as it returns after use.
<b>INSTANTANEOUS HEAT</b>	Instant water heating - there is never any waiting. Our ceramic water heater ensures high thermal efficiency and maintains an even water temperature 100% of the time.
<b>QUICK RELEASE</b>	Allows the Bidet to be released from the toilet with just the push of a button making the Bidet and toilet easy to clean.
<b>REMOTE CONTROL</b>	All functions are managed from an easy to use, intuitive remote control which can be hand held or mounted on the wall.
<b>MINI SIDE CONTROL</b>	Puts the main functions in a mini pad on the side of the seat.
<b>ULTRA STREAMLINE DESIGN</b>	This Bidet has a modern streamline design with soft lines that will make an attractive addition to your bathroom.
<b>FILTER IN-BUILT</b>	Internal filter providing additional protection in preventing sediment blocking the Bidet pump and spray nozzles.
<b>HEATED DRYER</b>	Warm air blower (dryer) can be set to a desirable temperature as it gently dries you. May take multiple uses depending on temperature and weather.
<b>MASSAGE/MOVE</b>	Moves the nozzle forward and backward in a rhythmic action for a more thorough cleansing and stimulating wash.
<b>NOZZLE POSITION ADJUST</b>	The nozzle is adjustable and can be directed to the correct spot.
<b>SELF DIAGNOSIS</b>	If a problem occurs, the LED on the main body flashes continually. The number of flashes and beeps will identify the problem.
<b>WIDE, MEDIUM, NARROW SPRAY</b>	This button changes the width of the spray pattern from a narrow to medium or wide spray, similar to your garden hose.
<b>PULSE</b>	The water sprays in a rhythmic pulsating action for a soothing stimulating wash.
<b>CHILD</b>	It adjusts the location of the nozzle, the water pressure and air temperature to suit children.
<b>DEODORISER</b>	Sucks foul air from the toilet bowl through a carbon filter reducing odours - carbon filter lasts up to 7 years.
<b>ENEMA</b>	A pencil thin stream of soft aerated water is ideal for constipation.
<b>USER PRESETS</b>	Each family member can press their own button and the Bidet remembers their preferred wash and dry temperature.
<b>WET AREA RATED IPX4</b>	Bidet model is water rated IPX4. It is designed to be installed and operated in wet area bathrooms.
<b>REMOVABLE SIDE REMOTE CONTROL</b>	Allows the remote control to be mounted on either side of the Bidet seat for easy use.
<b>STAINLESS STEEL NOZZLE/S</b>	Rear and front nozzles are hardened stainless steel, resisting soiling reducing bacterial growth and improving hygiene.
<b>SILVER IONISATION</b>	This Bidet generates its own colloidal silver that disinfects the Bidet every time you use it.
<b>FIT INTERNAL CISTERN</b>	The Bidet connection can be fitted through an intern cistern, plumber is required - Please phone for further details.
<b>FITS BACK TO WALL SUITE</b>	The 5mm pipe that fits this style of Bidet can be connected to the toilet tap situated inside the cistern.
<b>FIT ENCLOSED SUITE</b>	Bidets with a quick release mounting bracket allows the Bidet to be fitted to toilet pans with top fitting toilet seats and don't have access to the seat bolts.



**If you suffer from arthritis, back conditions, eye sight limitations, disabled or large body size this is the Bidet for you.**

**Available in:**

- Standard seat 
- Elongated seat 

The most versatile remote control Bidet on the market today featuring large easy to see raised buttons. Designed to provide the user with the utmost convenience.

The remote can be mounted on the wall or either side of the seat for ease of use for arthritic sufferers and the visually impaired.



### Tamper proof wall holder

**(Optional accessory)**

Designed so you don't accidentally change the temperature and wash settings. For ease of use for elderly clients.



**Warm water wash** Provides a warm stream of water that can be adjusted to a suitable spray style



## FEATURES

- NOZZLE (x2)
- WATER SAVING
- REAR CLEANSE
- COLD WATER OPTION
- ONE BUTTON WASH FUNCTION
- ANTI-BACTERIAL PLASTIC
- SIDE CONTROL (removable)
- FEMININE CLEANSE
- SOFT CLOSE HYDRAULIC LID
- ERGONOMIC SEAT
- FILTER EXTERNAL
- AIR AND WATER STREAM
- ENERGY (power) SAVE
- MF FILTER
- HEATED WATER
- NOZZLE CLEAN BUTTONS
- HEATED SEAT
- ELECTRICAL (power point req.)
- SEAT SENSOR
- SELF CLEANSING NOZZLES
- INSTANTANEOUS HEAT (fast heat)
- QUICK RELEASE
- REMOTE CONTROL
- MINI SIDE CONTROL
- ULTRA STREAMLINE DESIGN
- FILTER IN-BUILT
- HEATED DRYER
- MASSAGE/MOVE
- NOZZLE POSITION ADJUST
- SELF DIAGNOSIS
- WIDE, MEDIUM, NARROW SPRAY
- PULSE
- CHILD
- DEODORISER
- ENEMA (narrow spray)
- USER PRESETS
- WET AREA RATED IPX4
- REMOVABLE SIDE REMOTE CONTROL
- STAINLESS STEEL NOZZLES
- SILVER IONISATION
- FIT INTERNAL CISTERN
- FITS ALL BOTTOM FIX TOILETS
- FIT ENCLOSED SUITE

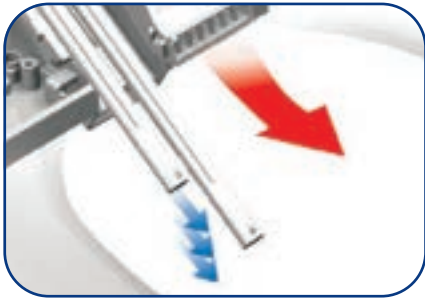

### Twin nozzles

Separate bottom and ladies wash nozzles thus removing any threat of cross contamination.

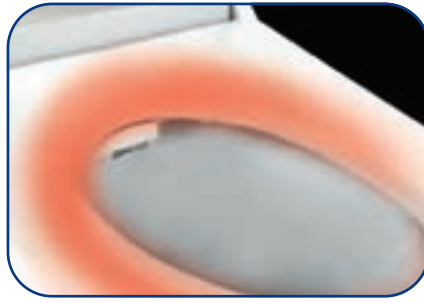

### Heated seat (4 level adjustment)

The ergonomic design allows comfort for extended use.



### Warm air dryer

After cleansing is complete, the warm air dryer leaves you feeling fresh and dry.

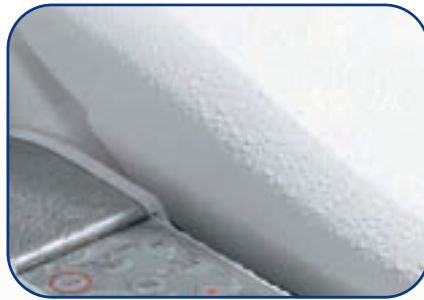

### Engineered for your safety

This product is engineered for safe use in wet environments.

## Preferred remote control Bidet for

- Occupational therapists ● Hospitals
- Retirement homes ● Healthcare professionals



The BA08 requires nuts to be fixed from underneath the pan, and will not work with sealed, back-to-wall pans. If unsure, please contact the supplier.

#### BA-08 A/R (Standard Seat)

This Bidet will fit on your existing toilet suite if the measurements of your pan are:

- A: 500mm or above
- B: Between 140-210mm
- C: 330mm or above
- D: 420mm or above

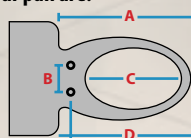

#### BA-08 A/E (Elongated Seat)

This Bidet will fit on your existing toilet suite if the measurements of your pan are:

- A: 520mm or above
- B: Between 140-210mm
- C: 340mm or above
- D: 440mm or above

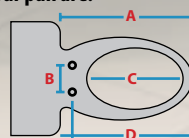

For detailed information and instructions **scan below** or **click here**





This Bidet has passed electrical and watermark certification. Local plumbing regulations may apply.

# Coway BA13a Luxury Range System

**COWAY**

Electric Bidet BA13a

**Available in:**

- Standard seat 
- Elongated seat 



## Stainless Steel Nozzles



## FEATURES

- NOZZLE (x2)
- WATER SAVING
- REAR CLEANSE
- COLD WATER OPTION
- ONE BUTTON WASH FUNCTION
- ANTI-BACTERIAL PLASTIC
- SIDE CONTROL
- FEMININE CLEANSE
- SOFT CLOSE HYDRAULIC LID
- ERGONOMIC SEAT
- FILTER EXTERNAL (optional)
- AIR AND WATER STREAM
- ENERGY (power) SAVE
- MF FILTER
- HEATED WATER
- NOZZLE CLEAN BUTTONS
- HEATED SEAT
- ELECTRICAL (power point req.)
- SEAT SENSOR
- SELF CLEANSING NOZZLES
- INSTANTANEOUS HEAT
- QUICK RELEASE
- REMOTE CONTROL
- MINI SIDE CONTROL
- ULTRA STREAMLINE DESIGN
- FILTER IN-BUILT
- HEATED DRYER
- MASSAGE/MOVE
- NOZZLE POSITION ADJUST
- SELF DIAGNOSIS
- WIDE, MEDIUM, NARROW SPRAY
- PULSE
- CHILD
- DEODORISER
- ENEMA
- USER PRESETS
- WET AREA RATED IPX4
- REMOVABLE SIDE REMOTE CONTROL
- STAINLESS STEEL NOZZLES
- SILVER IONISATION
- FITS INTERNAL CISTERN
- FITS BACK TO WALL SUITE
- FITS ENCLOSED SUITE

For detailed information and instructions **scan below** or **click here**



**BA-13 AR/BR (Standard Seat)**

This Bidet will fit on your existing toilet suite if the measurements of your pan are:

- A:** 480mm or above
- B:** Between 130-200mm
- C:** 310mm or above
- D:** 400mm or above

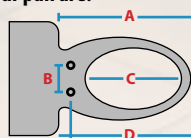

**BA-13 AE/BE (Elongated Seat)**

This Bidet will fit on your existing toilet suite if the measurements of your pan are:

- A:** 510mm or above
- B:** Between 130-200mm
- C:** 340mm or above
- D:** 430mm or above

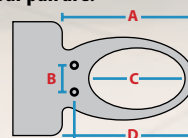

*This Bidet has passed electrical and watermark certification. Local plumbing regulations may apply.*



# Coway BA13b Luxury Range System

**COWAY** Electric Bidet BA13B

This luxury model has more features from the BA13a Mid Range System



## The difference between

**BA13a** Luxury Range System and **BA13b** Luxury Range System

## The BA13b has 3 additional features:

**Wide spray function** - This button changes the width of the spray pattern from a narrow to medium or wide spray, similar to your garden hose.

**Deodoriser** - Sucks foul air from the toilet bowl through a carbon filter reducing odours.

**Silver ionisation** - This Bidet generates its own colloidal silver that disinfects the Bidet every time you use it.



**COWAY** Voted  
 "Best Bidet in the World"  
 2 years in a row!  
 at the World Design Awards

## FEATURES

- NOZZLE (x2)
- WATER SAVING
- REAR CLEANSE
- COLD WATER OPTION
- ONE BUTTON WASH FUNCTION
- ANTI-BACTERIAL PLASTIC
- SIDE CONTROL
- FEMININE CLEANSE
- SOFT CLOSE HYDRAULIC LID
- ERGONOMIC SEAT
- FILTER EXTERNAL (optional)
- AIR AND WATER STREAM
- ENERGY (power) SAVE
- MF FILTER
- HEATED WATER
- NOZZLE CLEAN BUTTONS
- HEATED SEAT
- ELECTRICAL (power point req.)
- SEAT SENSOR
- SELF CLEANSING NOZZLES
- INSTANTANEOUS HEAT
- QUICK RELEASE
- REMOTE CONTROL
- MINI SIDE CONTROL
- ULTRA STREAMLINE DESIGN
- FILTER IN-BUILT
- HEATED DRYER
- MASSAGE/MOVE
- NOZZLE POSITION ADJUST
- SELF DIAGNOSIS
- WIDE, MEDIUM, NARROW SPRAY
- PULSE
- CHILD
- DEODORISER
- ENEMA (narrow spray)
- USER PRESETS
- WET AREA RATED IPX4
- REMOVABLE SIDE REMOTE CONTROL
- STAINLESS STEEL NOZZLES
- SILVER IONISATION
- FITS INTERNAL CISTERN
- FITS BACK TO WALL SUITE
- FITS ENCLOSED SUITE

For detailed information and instructions **scan below** or **click here**



This Bidet has passed electrical and watermark certification. Local plumbing regulations may apply.

# Installation Requirements

## Is the Bidet to be installed in a bathroom?

If the toilet is within 600mm of a shower screen or a bath as most are, the Bidet needs to be rated IPX4 for installation wet areas Zone 2 as per diagram A (below).

All of the Health Care Bidets are water rated **IPX4** so each Bidet can be installed safely in these wet areas.

All Bidets have passed electrical and watermark certification.

**Local plumbing regulations may apply.**



**WMTS 051  
20094**



**E5780**

**JAS-ANZ**



**ABCB**



**IPX4**

## Electrical Safety Assessment Certificate



## Backflow Requirements

Douche seats are supplied with a low-medium hazard backflow protection device complying with AS/NZS 2845.1

\*This device must be installed in accordance with AS/NZS 3500.1

A high hazard backflow prevention device will be required.

The manufacturer has designed this product for easy installation, in other countries most people do it themselves. In Australia, the plumbing code mandates that this product needs to be installed by a plumber and we do advise that you comply.

# Germ killing filters are standard

All of our products are supplied with MF silver-ion filters that help destroy bacteria, germs and viruses.

## How does the filter do that?

The filter is made in two parts. **The first** being a sediment filter that picks up particles that may be in the water. This protects the internal galleries from being clogged or build-up on the heating elements.



Nano Silver Ceramic Filter

EXAMPLE OF SILVER'S EFFECTS ON PATHOGENS:

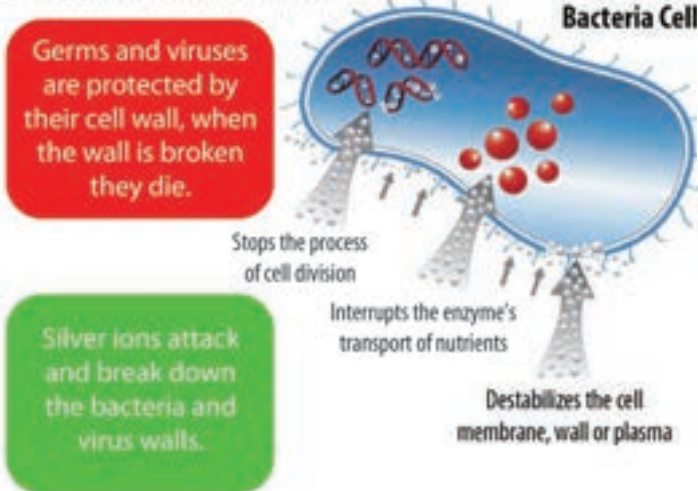

Bacteria growth with filter



Bacteria growth without filter

**The second** is the colloidal silver impregnated ceramic filter that helps remove bacteria, germs, and viruses by releasing ions in to the water stream.

## Benefits

Not only does it keep the internal tank and galleries germ free but helps remove these nasties from the areas on the person that it washes.

Australian and International studies have proven that this can be a major benefit in controlling issues such as UTI's.

Bacteria can be found everywhere. Our nano silver ceramic filter may help protect you and your family.

## Changing the filter is just like changing a light bulb\*

**To remove:** Simply grasp the filter in hand, turn 1/4 clockwise. Pull down carefully while holding the filter.



\*Coway products only. Other products have an easy to remove and install filter system.

Scan here for more information.





# Handspray Bidets

All the Handspray models are made from high quality chrome plated brass. Unlike other sprays available those are made of plastic and break easily.

All external and Internal parts are metal, this is the reason that only Handspray products can handle the high pressure water supply that many Australians experience in their homes.



## Accessories



**Diverter**



**Dual Check**



**350KPA  
Pressure Reducer**



**1.2m High Pressure  
Hose**

This handspray is watermarked as a tap outlet. It should be installed by a plumber in accordance with as/nzs 3500.1. When installed as a toilet douche a high hazard device will be required.

# Seat Raiser & Health Care Package

**NEW! – 3 in 1 arm design**



**Remove your toilet seat**



**Place the raiser**



**Fit the arms**

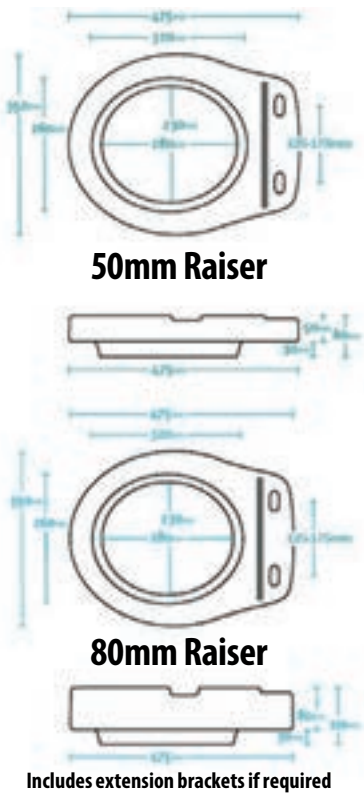

**Arms can be Splayed, Vertical or Folded Down to suit your needs**



**Bariatric Arms**  
For people over 120kgs

***If your toilet needs to be raised you can raise your toilet an additional 50-80mm by using our seat raiser attachment.***

# National



# coway

# InteliClean



**Sales enquiries:**

The Bidet Shop Australia | 07 5591 7744 | [thebidetshop.com.au](http://thebidetshop.com.au)

The Bidet Shop New Zealand | 09 320 3584 | [thebidetshop.co.nz](http://thebidetshop.co.nz)